

Article number: 03550050

Description: Fluro hydraulic rod end FPR 50S

## Measures

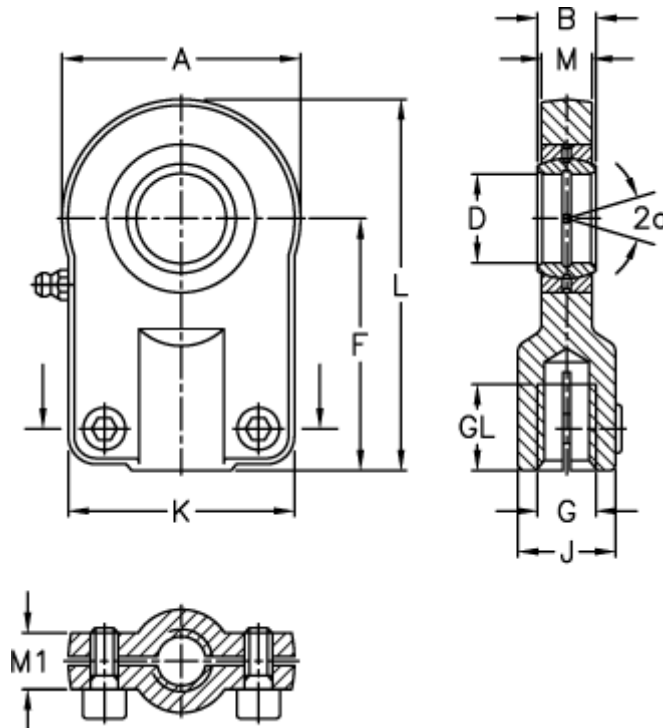

A	= 120	J	= 55
a (degrees)	= 6	K	= 105
B	= 35	L	= 190
D	= 50	M	= 30
Dynamic load C (kN)	= 156	M1	= 30
F	= 130	Static load C0 (kN)	= 245
g	= M33x2	Torque (N m)	= 86
GL	= 46	Weight	= 4400